

**FEATURES**

- ▶ Industrial SMD Package
- ▶ I/O Isolation 1500 VDC
- ▶ Operating Ambient Temp. Range -40°C to +90°C
- ▶ Water-washable Process Available(option)
- ▶ Qualified for Lead-free Reflow Solder Process  
According to IPC/JEDEC J-STD-020D.1
- ▶ Tape & Reel Package Available
- ▶ UL/cUL/IEC/EN 60950-1 Safety Approval

**PRODUCT OVERVIEW**

The MINMAX MSLU100 series is a range of 1W DC/DC converters in a SMD- Package featuring I/O-isolation of 1500VDC. The very small footprint makes this product the ideal solution for many applications where a voltage has to be isolated i.e for noise reduction, ground loop elimination, in digital interfaces or where a converted voltage is required.

An excellent efficiency allows an operating temperature range of -40°C to +90°C. With a new package design these converters are fully qualified for the higher temperature profile used in lead-free reflow solder processes. For automated SMD production lines the product can be supplied in tape & reel package.

**Model Selection Guide**

Model Number	Input Voltage (Range) VDC	Output Voltage VDC	Output Current		Input Current		Load Regulation % (max.)	Max. capacitive Load µF	Efficiency (typ.)		
			Max.	Min.	@Max. Load	@No Load			@Max. Load		
			mA	mA	mA(typ.)	mA(typ.)			%		
MSLU101	5 (4.5 ~ 5.5)	3.3	300	6	271	30	10	33	73		
MSLU102		5	200	4	256		10		78		
MSLU103		9	110	2	254		10		78		
MSLU104		12	84	1.5	259		8		78		
MSLU105		15	67	1	254		7		79		
MSLU106		±5	±100	±2	270		10		74		
MSLU108		±12	±42	±0.8	259		8		33#	78	
MSLU109		±15	±33	±0.7	254		7		78		
MSLU111	12 (10.8 ~ 13.2)	3.3	300	6	112	15	8	33	74		
MSLU112		5	200	4	109		8		76		
MSLU113		9	110	2	106		8		78		
MSLU114		12	84	1.5	106		5		79		
MSLU115		15	67	1	105		5		80		
MSLU116		±5	±100	±2	113		8		74		
MSLU118		±12	±42	±0.8	108		5		33#	78	
MSLU119		±15	±33	±0.7	104		5		79		
MSLU154	15 (13.5 ~ 16.5)	12	84	1.5	86	14	5	33	78		
MSLU155		15	67	1	86		5		78		
MSLU121	24 (21.6 ~ 26.4)	3.3	300	6	58	8	8	33	72		
MSLU122		5	200	4	54		8		78		
MSLU123		9	110	2	54		8		77		
MSLU124		12	84	1.5	55		5		77		
MSLU125		15	67	1	53		5		79		
MSLU126		±5	±100	±2	57		8		73		
MSLU128		±12	±42	±0.8	54		9		5	33#	78
MSLU129		±15	±33	±0.7	53				5		78

# For each output

Input Specifications					
Parameter	Conditions/Model	Min.	Typ.	Max.	Unit
Input Voltage Range	5V Input Models	4.5	5	5.5	VDC
	12V Input Models	10.8	12	13.2	
	15V Input Models	13.5	15	16.5	
	24V Input Models	21.6	24	26.4	
Input Surge Voltage (1 sec. max.)	5V Input Models	-0.7	---	9	
	12V Input Models	-0.7	---	18	
	15V Input Models	-0.7	---	20	
	24V Input Models	-0.7	---	30	
Internal Filter	All Models	Internal Capacitor			

Output Specifications					
Parameter	Conditions	Min.	Typ.	Max.	Unit
Output Voltage Balance	Dual Output, Balanced Loads	---	±0.1	±1.0	%
Line Regulation	For Vin Change of 1%	---	±1.2	±1.5	%
Load Regulation	Io=20% to 100%	See Model Selection Guide			
Ripple & Noise	0-20 MHz Bandwidth	---	---	120	mV <sub>P-P</sub>
Temperature Coefficient		---	±0.01	±0.02	%/°C
Short Circuit Protection	0.5 Second Max., Automatic Recovery				

General Specifications					
Parameter	Conditions	Min.	Typ.	Max.	Unit
I/O Isolation Voltage	60 Seconds	1500	---	---	VDC
	1 Second	1800	---	---	VDC
I/O Isolation Resistance	500 VDC	1000	---	---	MΩ
I/O Isolation Capacitance	100KHz, 1V	---	40	100	pF
Switching Frequency		50	100	140	KHz
MTBF (calculated)	MIL-HDBK-217F@25°C, Ground Benign	2,000,000	---	---	Hours
Moisture Sensitivity Level (MSL)	IPC/JEDEC J-STD-020D.1	Level 2			
Safety Approvals	UL/cUL 60950-1 recognition (CSA certificate), IEC/EN 60950-1 (CB-report)				

Environmental Specifications				
Parameter	Conditions	Min.	Max.	Unit
Operating Ambient Temperature Range (See Power Derating Curve)	Natural Convection	-40	+90	°C
Case Temperature		---	+90	°C
Storage Temperature Range		-50	+125	°C
Humidity (non condensing)		---	95	% rel. H
Cooling	Natural Convection			
Lead-free Reflow Solder Process	IPC/JEDEC J-STD-020D.1			

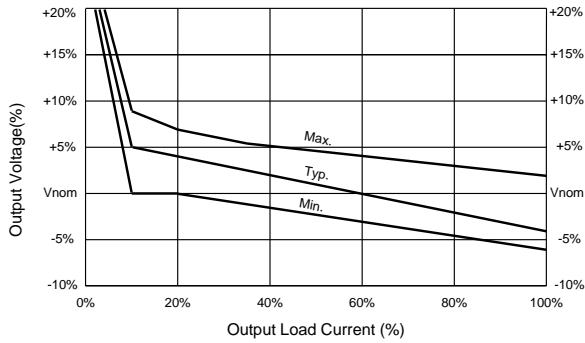
**Output Voltage Tolerance**

(3.3V &amp; 5V Output)

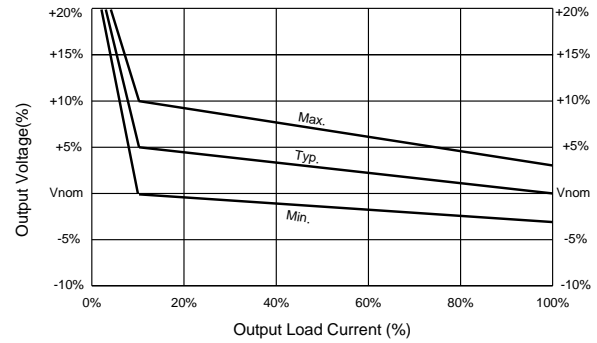

(All other Output)

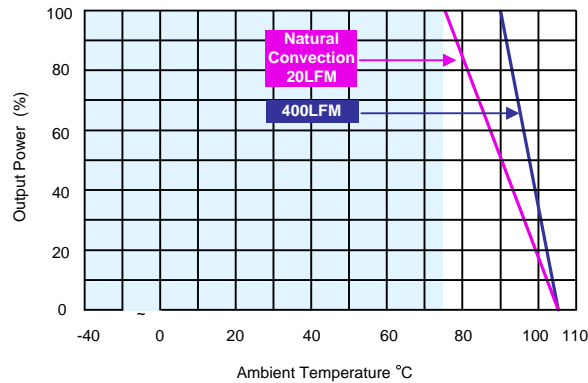
**Power Derating Curve**

**Notes**

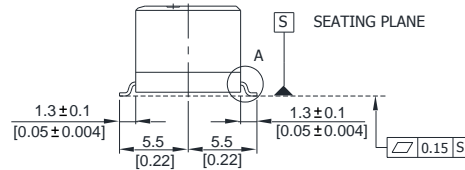
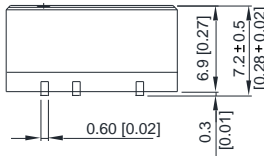
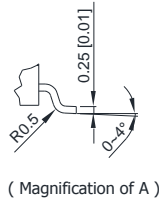
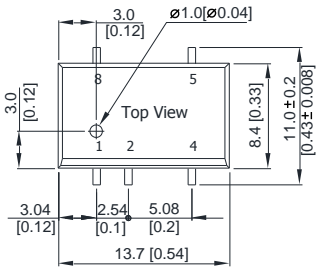
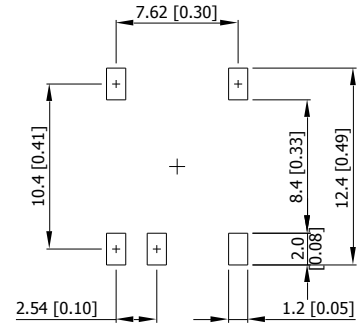
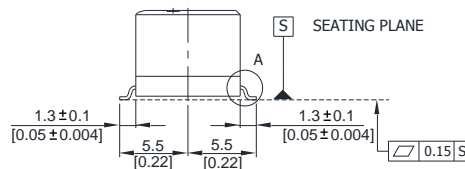
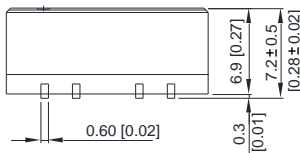
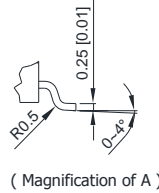
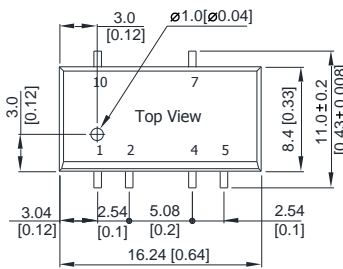
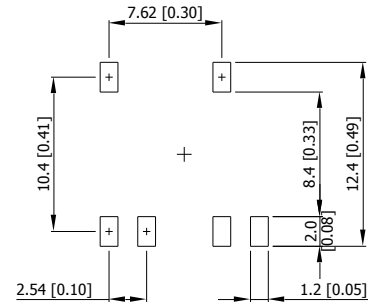
- 1 Specifications typical at  $T_a = +25^\circ\text{C}$ , resistive load, nominal input voltage and rated output current unless otherwise noted.
- 2 These power converters require a minimum output loading to maintain specified regulation, operation under no-load conditions will not damage these modules; however they may not meet all specifications listed.
- 3 We recommend to protect the converter by a fast blow fuse in the input supply line.
- 4 Other input and output voltage may be available, please contact factory.
- 5 That "natural convection" is about 20LFM but is not equal to still air (0 LFM).
- 6 Specifications are subject to change without notice.

**Package Specifications**
**Mechanical Dimensions (Single Output)**

**Connecting Pin Patterns**

**Mechanical Dimensions (Dual Output)**

**Connecting Pin Patterns**

- ▶ All dimensions in mm (inches)
- ▶ Tolerance: X.X±0.25 (X.XX±0.01)  
X.XX±0.13 (X.XXX±0.005)
- ▶ Pins ±0.05 (±0.002)

**Pin Connections**

Pin	Single Output	Dual Output
1	-Vin	-Vin
2	+Vin	+Vin
3	No Pin	No Pin
4	-Vout	Common
5	+Vout	-Vout
6	No Pin	No Pin
7	No Pin	+Vout
8	NA	No Pin
9	---	No Pin
10	---	NA

NA : Not Available for Electrical Connection

**Physical Characteristics**

Case Size (Single Output)	: 13.7x8.4x6.9mm (0.54x0.33x0.27 inches)
Case Size (Dual Output)	: 16.24x8.4x6.9mm (0.64x0.33x0.27 inches)
Case Material	: Non-Conductive Black Plastic (flammability to UL 94V-0 rated)
Pin Material	: Phosphor Bronze
Weight (Single Output)	: 1.7g
Weight (Dual Output)	: 2.0g

Order Code Table	
Standard	For water-washable process
MSLU101	MSLU101-W
MSLU102	MSLU102-W
MSLU103	MSLU103-W
MSLU104	MSLU104-W
MSLU105	MSLU105-W
MSLU106	MSLU106-W
MSLU108	MSLU108-W
MSLU109	MSLU109-W
MSLU111	MSLU111-W
MSLU112	MSLU112-W
MSLU113	MSLU113-W
MSLU114	MSLU114-W
MSLU115	MSLU115-W
MSLU116	MSLU116-W
MSLU118	MSLU118-W
MSLU119	MSLU119-W
MSLU154	MSLU154-W
MSLU155	MSLU155-W
MSLU121	MSLU121-W
MSLU122	MSLU122-W
MSLU123	MSLU123-W
MSLU124	MSLU124-W
MSLU125	MSLU125-W
MSLU126	MSLU126-W
MSLU128	MSLU128-W
MSLU129	MSLU129-W

## Test Setup

### Input Reflected-Ripple Current Test Setup

Input reflected-ripple current is measured with an inductor  $L_{in}$  (4.7 $\mu$ H) and  $C_{in}$  (220 $\mu$ F, ESR < 1.0 $\Omega$  at 100 KHz) to simulate source impedance. Capacitor  $C_{in}$ , offsets possible battery impedance.

Current ripple is measured at the input terminals of the module, measurement bandwidth is 0-500 KHz.

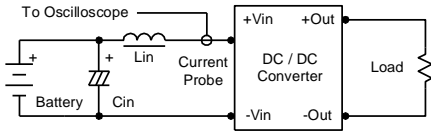

### Peak-to-Peak Output Noise Measurement Test

Use a  $C_{out}$  0.33 $\mu$ F ceramic capacitor. Scope measurement should be made by using a BNC socket, measurement bandwidth is 0-20 MHz. Position the load between 50 mm and 75 mm from the DC/DC Converter.

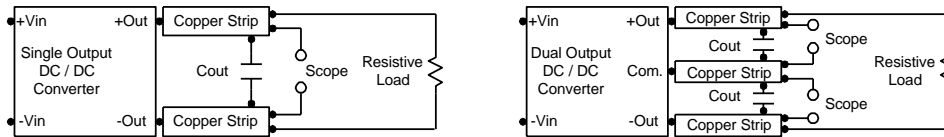

## Technical Notes

### Maximum Capacitive Load

The MSLU100 series has limitation of maximum connected capacitance at the output. The power module may be operated in current limiting mode during start-up, affecting the ramp-up and the startup time. For optimum performance we recommend 33 $\mu$ F maximum capacitive load. The maximum capacitance can be found in the data sheet.

### Input Source Impedance

The power module should be connected to a low ac-impedance input source. Highly inductive source impedances can affect the stability of the power module.

In applications where power is supplied over long lines and output loading is high, it may be necessary to use a capacitor at the input to ensure startup.

Capacitor mounted close to the power module helps ensure stability of the unit, it is recommended to use a good quality low Equivalent Series Resistance (ESR < 1.0 $\Omega$  at 100 KHz) capacitor of a 2.2 $\mu$ F for the 5V input devices, a 1.0 $\mu$ F for the 12V input devices and a 0.47 $\mu$ F for the 24V input devices.

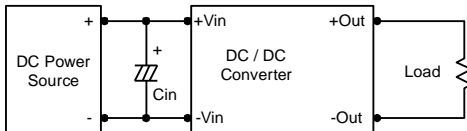

### Output Ripple Reduction

A good quality low ESR capacitor placed as close as practicable across the load will give the best ripple and noise performance. To reduce output ripple, it is recommended to use 3.3 $\mu$ F capacitors at the output.

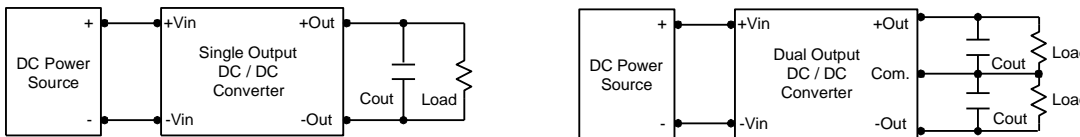

### Thermal Considerations

Many conditions affect the thermal performance of the power module, such as orientation, airflow over the module and board spacing. To avoid exceeding the maximum temperature rating of the components inside the power module, the case temperature must be kept below 90°C. The derating curves are determined from measurements obtained in a test setup.

